

**GET YOURS TODAY!  
THE LOCKNLUBE®  
AIR CHUCK**

**THE LOCKNLUBE® GREASE COUPLER  
FITS ANY GREASE GUN!  
Manual, Battery, or Pneumatic**

# **LOCKNLUBE**

## **PRODUCT CATALOG**

**LOCKNLUBE.COM**  
**603-795-2298**

**TO SEE COMPLETE PRODUCT SELECTION**  
**U.S. ORDERS OVER \$25 SHIP FOR FREE**

# LOCKNLUBE

LockNLube was founded by farmers and loggers with the simple mission to end greasing frustration. To this day we are laser-focused on providing our customers with the best tools, the best guarantee, and the best customer service we can provide.

Our tools are built to stand up to the heavy use and demands of farming, excavation, logging, trucking, tire shops, service bays, and garages! Whether it is our original LockNLube® Grease Coupler, revolutionary LockNFlate® Air Chuck, or any of our best-selling grease guns, accessories, air or fencing tools, LockNLube sells the world's best tools and equipment to make machine maintenance faster, easier, and cleaner.

## TABLE OF CONTENTS

<b>LOCKNLUBE® GREASE COUPLERS</b> .....	4-5
<b>LOCKNFLATE® AIR CHUCKS</b> .....	6-7
<b>LOCKNLUBE GREASING TOOLS</b>	
Grease Gun Upgrades.....	8-9
Grease Guns.....	10-16
Keep it clean! Barrel Caps & more!.....	17
Grease.....	19
Greasing Adapters & Hoses.....	20-23
Grease Fittings (Zerks).....	24-26
Grease Fitting Relocation Kits.....	27
Shop & Storage Tools.....	28-29
The Original Grease Buster® & Accessories.....	30
<b>HYDRAULIC</b>	
Hosebox Hydraulic Fitting Kits.....	31
<b>LOCKNFLATE AIR TOOLS</b>	
Inflators & Accessories.....	32-35
Pressure Gauges & Adapters.....	36-37
<b>FENCE &amp; FARM</b>	
Clip Bender®.....	38
Jake's Wire Tighteners.....	39
Wand Wizard.....	40
<b>AND MORE!</b>	
LockNLube Apparel.....	41
Warranty Information.....	42
Mail In Order Form.....	43

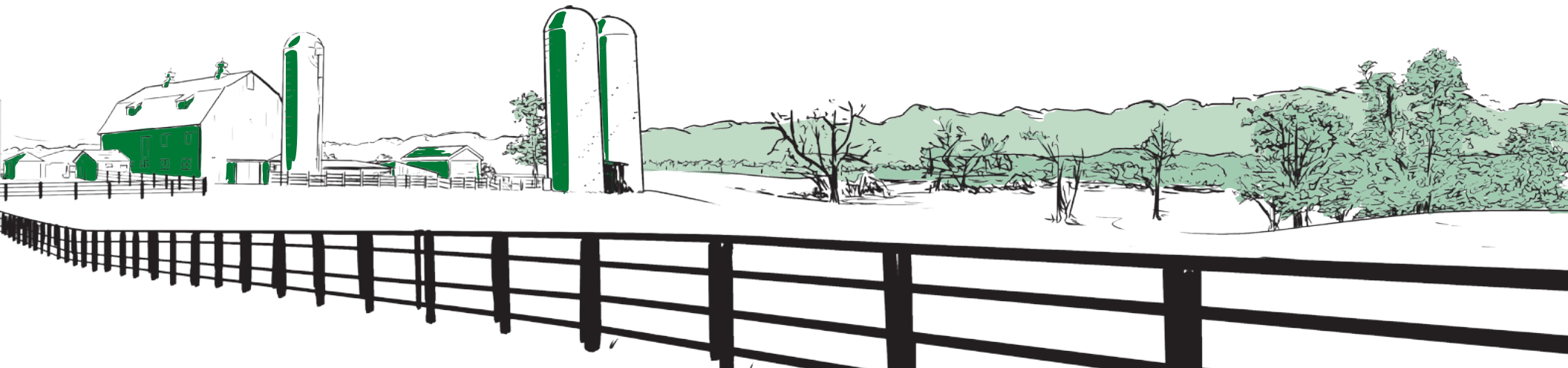

# LOCKNLUBE®

## GREASE COUPLER

BEST  
SELLER

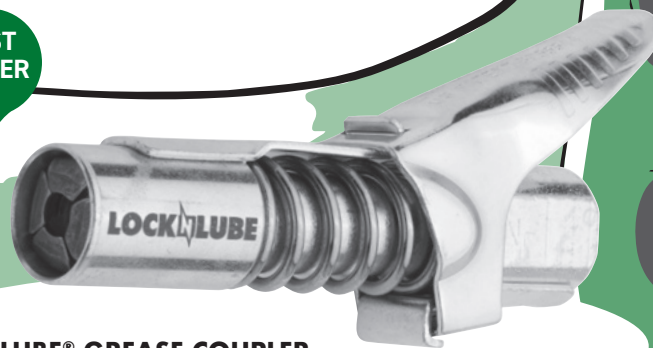

### LOCKNLUBE® GREASE COUPLER

GC81011      \$32.99

Replace your existing coupler with a LockNLube® Grease Coupler, and end greasing frustration! 1/8" NPT thread, works with all grease guns and Zerk fittings. Finally, a grease coupler that really works – hands-free, no mess, and no wasted grease! Includes a free Rebuild Kit (GC81012).

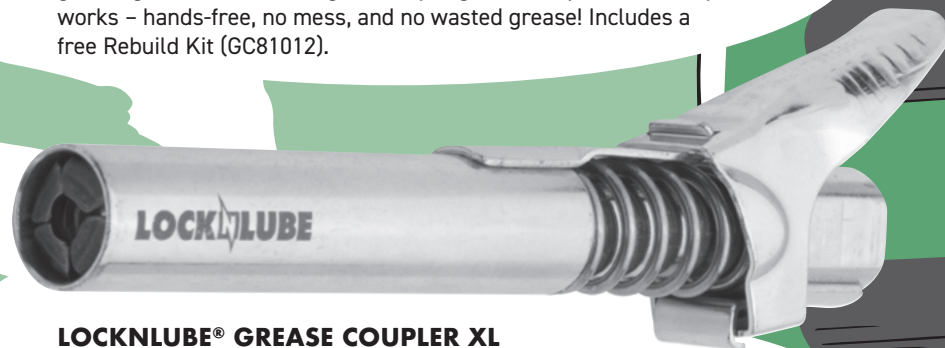

### LOCKNLUBE® GREASE COUPLER XL

GC81042      \$41.99

The LockNLube® Grease Coupler XL features the same locking technology as the original LockNLube® Grease Coupler. A longer barrel gives over 3.5" of effective reach. Perfect for greasing U-joints, harvester heads, shielded PTO shafts, and deeply recessed Zerks. Includes a free Rebuild Kit (GC81012).

### LOCKNLUBE® GREASE COUPLER REBUILD KIT

Available individually or in cost-saving multi-packs

GC81012      \$9.99

GC81012-3    \$24.99

GC81012-10   \$70.99

Easily replace the rubber seal and jaws on your LockNLube® Grease Coupler. Rebuild Kit fits both LockNLube® couplers.



# LOCKNFLATE® AIR CHUCK

**LOCKS ON—STAYS ON—WON'T LEAK**

LNL65002 CLOSED FLOW \$39.99  
LNL65001 OPEN FLOW \$39.99

Like no other air chuck on the market, the LockNFlate's six steel jaws lock onto any Schrader valve to create a secure, hands-free connection. The heavy-duty construction is built to last and stand up to everyday use in even the busiest tire shops, service bays, and garages.

**Features:**

- Fits standard Schrader valves [VG8/8V1 valve threads]
- Rated to 150 PSI
- 1/4" NPT Thread Size, fits most standard air hoses
- Heavy-duty construction for strength and durability.
- Available in 2 styles: Open Flow or Closed Flow

**BEST  
SELLER**

Six precision-milled  
jaws for unparalleled  
grip and control

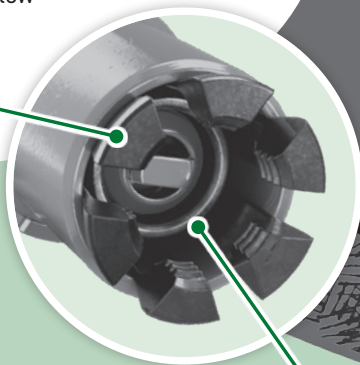

Durable  
spring-loaded  
TPU seal

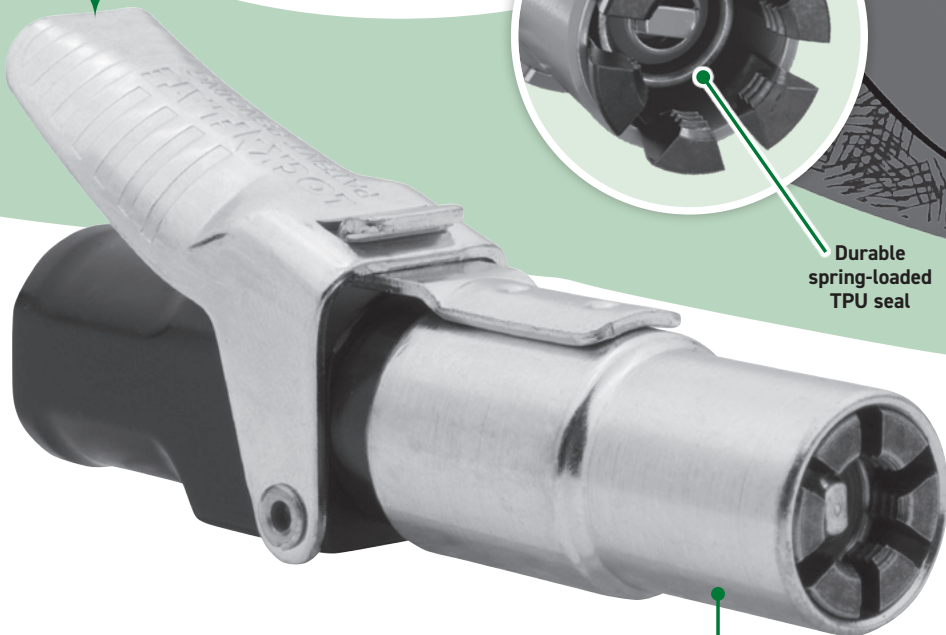

Sliding sleeve securely locks the  
air chuck onto the Schrader valve

**COMING SOON**

**LOCKNFLATE® 90°**  
90° right-angle air chuck perfect for  
motorcycles, bikes, ATVs, and other  
difficult-to-reach tire valves

**LOCKNFLATE® BIG BORE**  
For large tires on heavy equipment  
such as large trucks, trailers, and  
tractors. Fits large bore Schrader  
valves (VG12/12V1 valve threads)

**CLOSED FLOW:**

Must engage the tire valve for air  
to flow. For use directly from a  
compressor or air hose.

**OPEN FLOW:**

Air passes through freely on or off  
the valve stem. For use with inflator  
gauges and automatic systems.

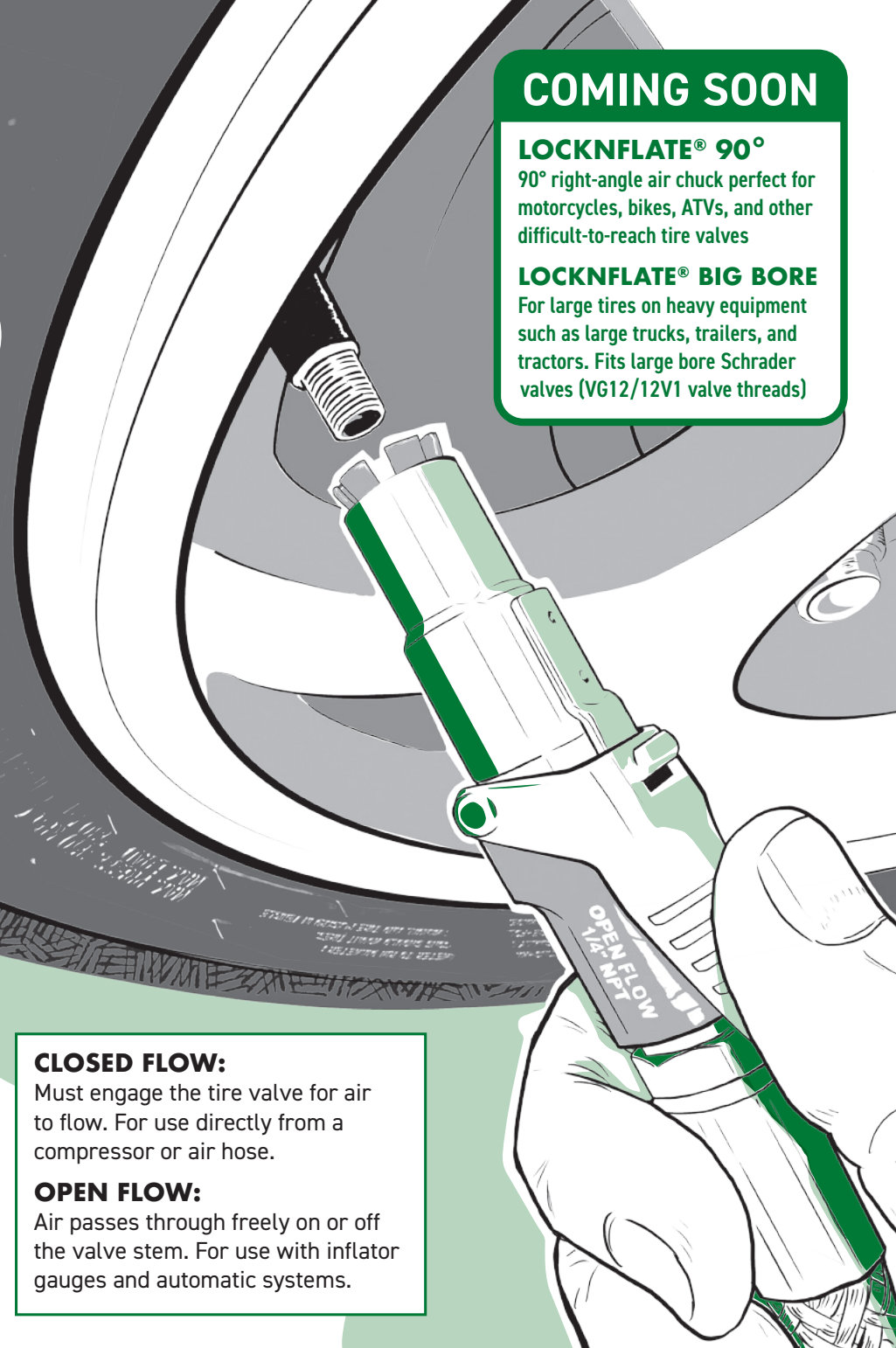

## IN-LINE HOSE SWIVELS

LNL231	1/8" NPT	\$11.99
LNL231-F	7/16"-28	\$11.99
LNL231-C	7/16"-20	\$11.99

The LockNLube In-line Hose Swivel is built to withstand up to 10,000 PSI so that you can use it with any grease gun - battery, pneumatic, or hand-pump. Our reinforced design also stands up to lateral pressures that get put on a grease gun hose, not just the pressure of the grease moving through it. Our traditional and best-selling 1/8" NPT swivel fits almost every manual grease gun. The 7/16" swivels are engineered to match the threads and specs of battery-operated grease guns from most major manufacturers. Available in standard, fine and coarse threads.



**LNL231** 1/8" NPT Standard  
For manual grease guns

**LNL231-F** Fine Threads (7/16"-28)  
Compatible with Dewalt and Lincoln



**LNL231-C** Coarse Threads (7/16"-20)  
Compatible with Milwaukee, Ryobi, Ridgid and Alemite

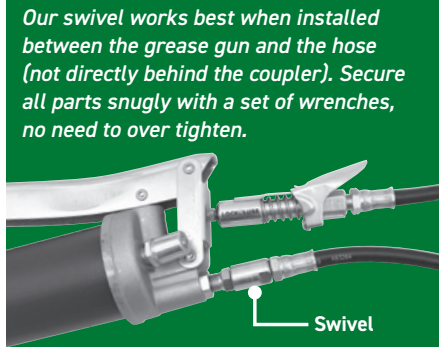

Our swivel works best when installed between the grease gun and the hose (not directly behind the coupler). Secure all parts snugly with a set of wrenches, no need to over tighten.

Swivel

## LOCKNLUBE HOSE ASSEMBLY COUPLER, HOSE, AND SWIVEL

**LNL321** \$46.99

You save 15% vs. buying all 3 separately!

To upgrade your grease gun, unscrew your current hose and coupler, and screw in our pre-assembled Coupler-Hose-Swivel unit. End greasing frustration with LockNLube!

This assembly bundle includes the LockNLube® Grease Coupler, a high-quality 20" whip hose, and our 10,000 PSI rated hose swivel. LockNLube Rebuild Kit included.



## THE LOCKNLUBE PRESSURE RETURN VALVE

LNL83100-M	\$59.99
LNL81300-D	\$59.99
LNL81300-L	\$59.99

The LockNLube Pressure Return Valve allows grease to flow from the hose back to the barrel with just the twist of a knob. No more pressure locks and messy, unsafe disconnects.

- Eliminates waste and extends coupler life.
- Installs in minutes!
- A MUST-HAVE for your cordless grease gun!

Three versions customized to the most popular Battery Grease Guns:

- **LNL83100-M** For the Milwaukee® M18™ and M12™ as well as RYOBI® ONE+ 18V
- **LNL81300-D** For the DeWalt® 20V Max\*
- **LNL81300-L** For the Lincoln® 1800-Series PowerLuber

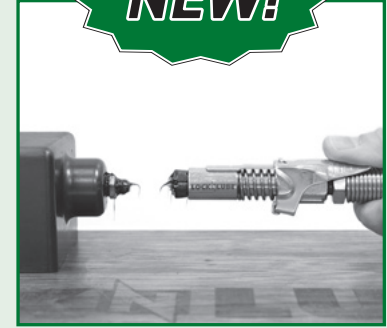

No more pressure locks!

Returns grease to the tube.

Releases pressure from the hose.

No more messy disconnects!

The greatest innovation in greasing since the original LockNLube® Grease Coupler!

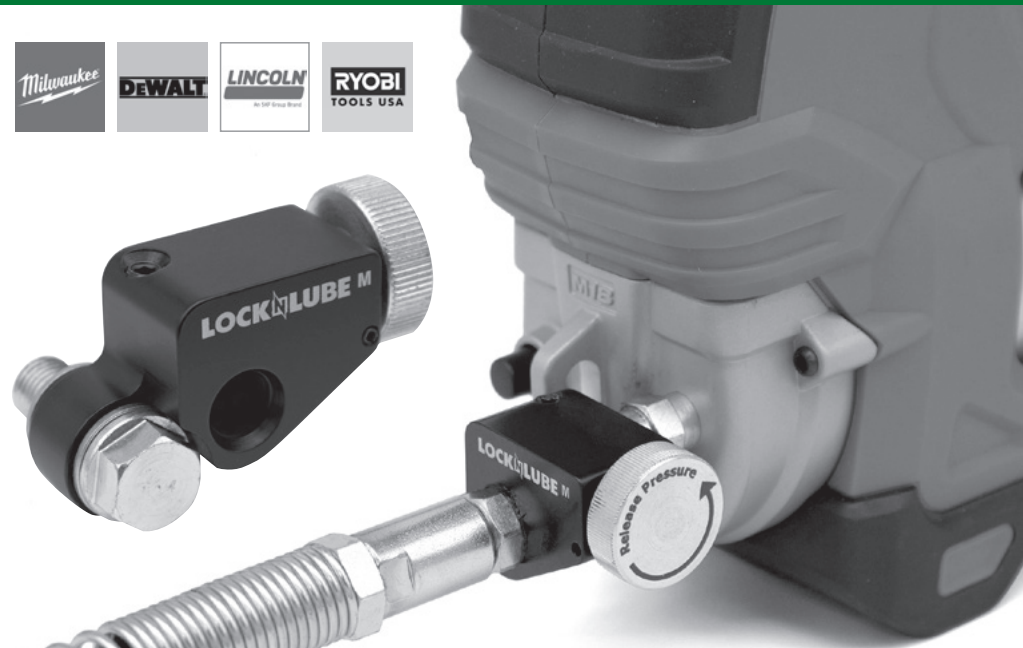

# SHOP OUR BEST-SELLING GREASE GUNS

LockNLube grease guns include the LockNLube® Grease Coupler, in-line hose swivel, and heavy-duty grease hose. **End greasing frustration!**

## LOCKNLUBE HEAVY-DUTY PISTOL GRIP GREASE GUN LNL153 \$69.99

The LNL153 is a heavy-duty grease gun that gets the job done! We include a high-quality 20" hose, In-line Hose Swivel, and LockNLube® Grease Coupler. We guarantee that the coupler locks on and won't leak. When you're done greasing just push the thumb lever down to release.

The rubber grip and shaped handle make this grease gun comfortable in the hand. Rated up to 5,000 PSI, this gun puts out plenty of pressure to handle sticky fittings. Includes an air bleeder valve so you can load and prime the gun easily.

**BEST SELLER**



## LOCKNLUBE HEAVY-DUTY LEVER GREASE GUN LNL151 \$69.99

A heavy-duty lever grease gun that delivers an ounce of grease in 28 strokes and rated up to 10,000 PSI. Uses a standard 14 oz. cartridge. A 20" heavy-duty hose with In-line Swivel and LockNLube® Grease Coupler makes greasing fast, clean, and easy.

Our "Loop & Lock" storage feature allows you to secure the coupler when not in use. This means no more greasy mess on your clothes, truck, and shop from loose hoses flying around when you pick up the grease gun.

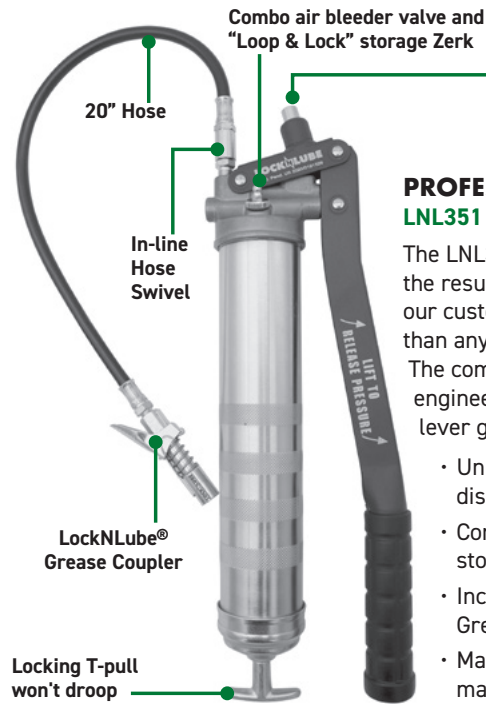
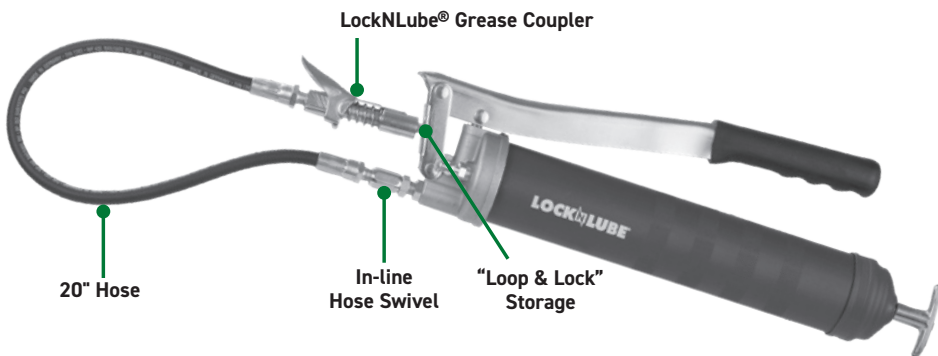

*Innovative design eliminates back pressure by returning grease directly to the grease cartridge for an easy, mess-free disconnect from clogged grease fittings*

## PROFESSIONAL SERIES LEVER GREASE GUN LNL351 \$119.99

The LNL351 Professional Series Lever Grease Gun is the result of years of work based on feedback from our customers. We designed this gun to work better than anything out there, both for use and storage. The combination of unique features and precision engineering make this the gold standard for what a lever grease gun can be.

- Unique pressure return system allows for easy disconnect from clogged fittings
- Combo air bleeder valve and "Loop & Lock" storage Zerk means clean and easy storage
- Includes the original patented LocknLube® Grease Coupler, In-line Hose Swivel and 20" hose
- Machined zinc head reduces air pockets to make reloading and priming easy

## PROFESSIONAL SERIES DUAL-MODE PISTOL GRIP GREASE GUN LNL353 \$119.99

**THE EASIEST WAY TO BUILD HIGH PRESSURE IN A PISTOL GRIP!**

Easy one hand toggle to switch from High Volume to High Pressure mode. The patented 2-Piston mechanism mimics the pressure or volume you'd expect from a lever gun with the one-handed operation of a pistol grip. Our included LockNLube® Grease Coupler, In-line Hose Swivel, and 20" whip hose mean no leaks, no mess, and no hands needed to keep the coupler in place.

- Easy one hand toggle to switch from High Volume to High Pressure mode.
- Choice of Top or Front Discharge Port
- Patented 2-Piston Mechanism

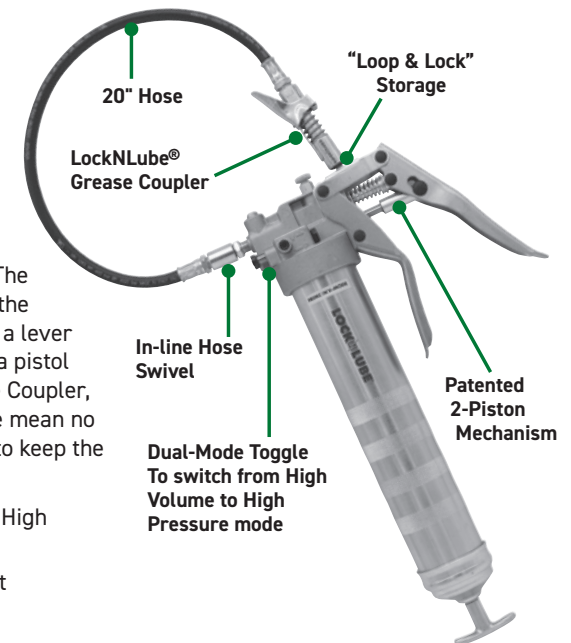

## LOCKNLUBE EASY-PRIME GREASE GUNS

LEVER	LNL251	\$89.99
PISTOL	LNL254	\$99.99

Easy-priming, high pressure, and European-engineered, the LockNLube Easy-Prime Grease Guns will change your idea of what a grease gun can be. The lightweight design does away with the follower rod and plate, replacing them with a simple, reusable cap. The plastic follower is pulled up as you grease and scrapes the tube clean—no drips, no mess! The precision design allows for fast and easy priming, enabled by a vacuum seal that keeps the follower sealed tightly. Our included LockNLube® Grease Coupler, In-line Hose Swivel, and 20" whip hose mean no leaks, no mess, and no hands needed to keep the coupler in place.

The LNL254 Pistol Grip version adds a Dual Delivery Mode: Toggle for High Pressure (5,000 PSI max) or High Volume delivery (27 strokes/ounce).

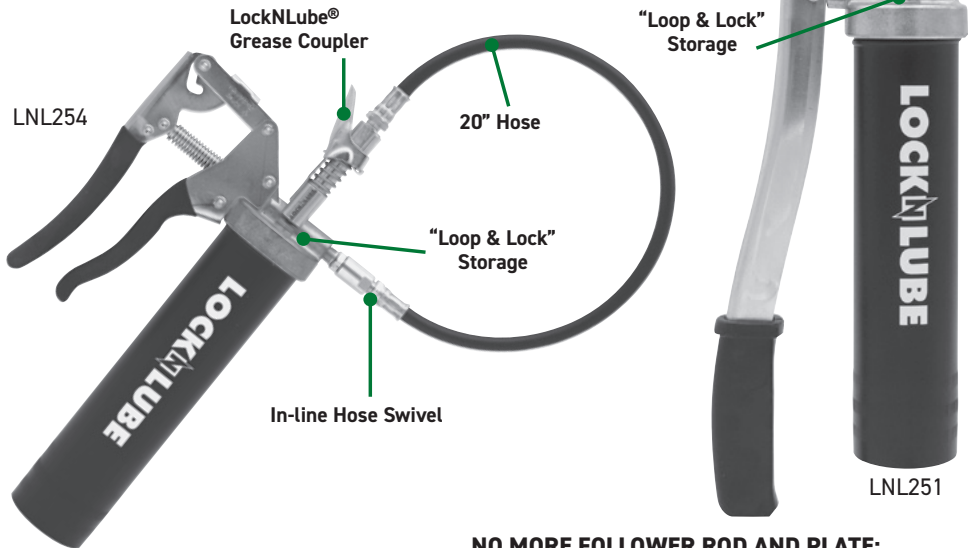

LNL254

LNL251

### NO MORE FOLLOWER ROD AND PLATE:

Simple, reusable cap seals tightly from the bottom and uses the maximum amount of grease in the cartridge.

Includes TEN Reusable Caps

Extra caps sold separately on our website. SKU: 14900

Precision rolled threads on the barrel lock tight with fewer spins and no cross threading.

## LOCKNLUBE SPIN-ON GREASE GUNS

LEVER	LNL155	\$89.99
PISTOL	LNL154	\$89.99

The LockNLube Spin-On Grease Gun uses convenient, threaded grease cartridges.

Uncap the cartridge, spin it into the gun, and get greasing! The pre-installed follower is pulled up as you grease and scrapes the cartridge clean. No oily drips or wasted grease!

- Designed to work ONLY with 14.5 oz/400 gm threaded grease cartridges
- The Spin-On Grease Guns create a vacuum that pulls grease up and into the head. This ensures full utilization of grease in the cartridge, and eliminates the spring-loaded follower and most common priming issues
- Permits fast & easy reloading without unscrewing the head. No air pockets or air bleeding required, just push up on the plastic follower

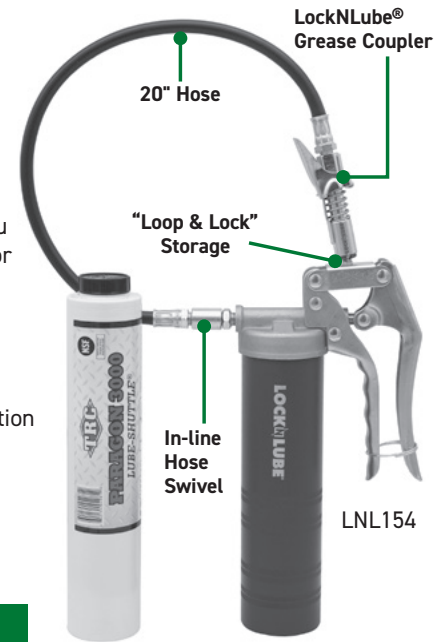

LNL154

LNL155

Both include a cartridge of grease

## SIMPLE-LIGHT-CLEAN

The LockNLube Spin-On Grease Gun uses convenient threaded grease cartridges. Uncap the cartridge, spin it into the gun, and get greasing! The pre-installed follower is pulled up as you grease and scrapes the cartridge clean. No oily drips or wasted grease!

INCLUDES A CARTRIDGE OF GREASE

## No Drips-No Mess -No Fuss



### PARAGON 3000 LITHIUM GREASE LUBE-SHUTTLE®

108500-1097	(SINGLE CARTRIDGE)	\$21.99
108500-1096	(PACK - 10 CARTRIDGES)	\$160.99
108500-1097-40	(CASE - 40 CARTRIDGES)	\$596.99

## LOCKNLUBE PREMIUM PISTOL GRIP GREASE GUN

**LNL252 \$79.99**

The LockNLube Premium Pistol Grip Grease Gun delivers up to 8,000 PSI. A cast aluminum head combines extreme durability and lightweight construction. A large ergonomic handle means you have more grip on the grease gun, and an integrated handle clip makes storage clean and easy.

- Up to 1-1/2 times more grease per stroke than other pistol grip guns
- Develops up to 8,000 PSI (551 BAR), not found in commonly sold pistol grip grease guns
- Rugged barrel with 0.049" (1.2 mm) wall thickness
- Heavy duty follower spring
- High tolerance CNC machined, aluminum die cast head
- Includes "Loop and Lock" Storage Technology



## MINI GREASE GUN

**LNL156 \$59.99**

Small size fits easily into a toolbox or storage compartment. Develops 3,500 PSI.

**Includes:** LockNLube® Grease Coupler, 12" Hose, and In-line Hose Swivel



## AIRTEC G200 EP GREASE 3 oz. GREASE CARTRIDGES

**G200EP-3 \$13.99**

Calcium complex, extreme weather grease.

3 Pack of 3 oz. grease "mini" cartridges. Perfect fit for the LockNLube Mini Grease Gun.

NLGI#2 - 535° F temp rating



Holds two gallons of bulk grease

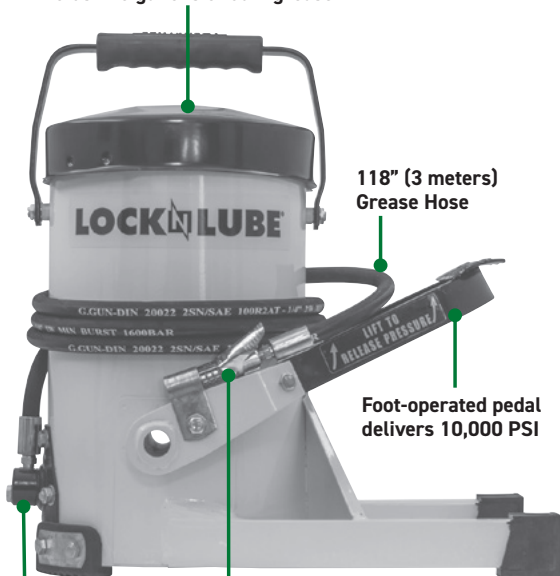

## G.GUN GREASE GUN

**GG80004 \$249.99**

The ultimate in industrial greasing strength – foot-operated, over two gallon capacity, 10,000 PSI output, patented pressure return valve that eliminates pressure locks. Delivers an ounce of grease in just 11 strokes. Includes a LockNLube® Grease Coupler, G.Scoop, and 3 meter long hose.



## G.SCOOP GS30001 \$25.00

Included with the G.Gun and separately available for purchase. The easiest and cleanest way to move bulk grease.

## 4-IN-1 GREASE INJECTION GUN KIT

**LNL253 \$54.99**

LockNLube's most versatile and unique grease gun. Our precision-machined injection grease gun builds up to 2,000 PSI, won't leak from the push button, and can be used to grease Zerk fittings, slides, bearings, or other jobs that require a fine or precise grease application.

**Includes:**

- **Two (2) Tips:** Precise brass needle for a fine line of grease and precise applications. Zerk fitting applicator for greasing Zerk (grease) fittings
- **Four (4) loading options:** bulk grease reservoir, standard lipped (paper) cartridges, threaded grease cartridges, screw-in tubes (9/16 UNF thread)



## 2-IN-1 PNEUMATIC GREASE GUN

LNL262

\$99.99

Single-shot and continuous delivery modes in one grease gun!

Easily switch delivery mode with sliding selection lever.

### Features:

- Heavy-duty and durable die-cast head with precision honed internal bore for rapid action
- T-pull locks to the side for easy loading and priming
- Air bleeder valve helps with priming
- "Loop & Lock" storage technology for easy storage and carrying

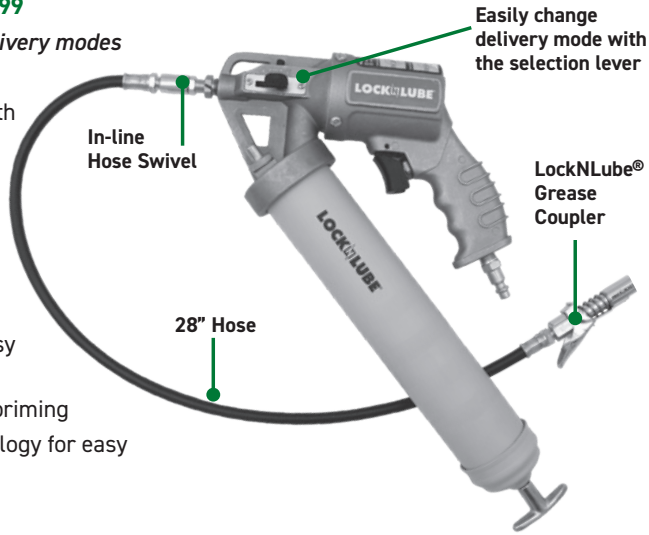

## MILWAUKEE® M18™ CORDLESS 2-SPEED GREASE GUN

GUN ONLY (NO BATTERY OR CHARGER) MIL2646-20-11 \$265.99

GUN +1 BATTERY, CHARGER & CASE MIL2646-21-11 \$329.99

GUN +2 BATTERIES, CHARGER & CASE MIL2646-22-11 \$389.99



The Milwaukee® M18™ Cordless 2-Speed Grease Gun delivers maximum pressure and unmatched versatility, offering 10,000 PSI max operating pressure and a patent pending pre-set counter that allows service and maintenance professionals to dispense precise amounts of grease.

The tool's two-speed design toggles max pressure and max flow rate. Other unique features include an on-board LED light, a lock-on/lock-off trigger, and a plunger rod with markings to gauge how much grease is left in the barrel.

**ALL MODELS include the LockNLube® Grease Coupler and In-line Hose Swivel (LNL231-C)**

- MIL2646-20-11 is the Bare Tool and **does not include batteries or charger.** Order only if you already have other Milwaukee 18V battery tools and don't need the full kit.
- MIL2646-21-11 - Includes 1 Battery and the Charger
- MIL2646-22-11 - Includes 2 Batteries and the Charger

The 21-11 and 22-11 models include the new multi-voltage charger so you can charge all M12™ and M18™ lithium-ion batteries with one charger.



## KEEP IT CLEAN!

Stops drips and leaks with a high-quality nitrile rubber cap for both the Coupler end and the grease gun's barrel. Clean Zerks extend coupler life and resist clogs, check out our fitting caps!

### GREASE GUN BARREL CAP

LNL161 YELLOW \$7.99

LNL165 GREEN \$7.99

LNL166 BLACK \$7.99

The Grease Gun Barrel Cap, a.k.a. *Grease Gundo*, is a perfect addition to any grease gun. Compatible with any standard 14 oz. grease gun (manual, cordless, pneumatic), it stops drips and leaks with a high-quality nitrile rubber cap. Available in three colors, this tool helps operators using different greases to color code their grease guns and avoid cross-contamination.



BEST SELLER

### GREASE COUPLER CAP

LNL181 YELLOW SINGLE \$.99

LNL182 ORANGE 5 PACK \$3.99

LNL183 RED 10 PACK \$5.99

LNL184 BLUE

LNL185 GREEN

LNL186 BLACK

The coupler cap keeps your grease coupler clean when not in use.



### GREASE FITTING CAPS

LNL134 YELLOW \$9.99

LNL137 RED \$9.99

Bag of 50 caps. Fits all standard grease fittings - SAE & Metric. Integrated collar slides onto the fitting, keeping the cap safely attached.



**LockNlube®  
Grease Coupler**  
Page 5

**In-line Hose  
Swivel**  
Page 8

**LNL151 Heavy-duty  
Lever Grease Gun**  
Page 10

**Grease Gun  
Barrel Cap**  
Page 17



<b>PARAGON 3000 LITHIUM GREASE</b>		
108500	(SINGLE CARTRIDGE)	\$19.99
108500-10	(PACK - 10 CARTRIDGES)	\$132.99
108500-40	(CASE - 40 CARTRIDGES)	\$490.99
108500-4055	(45 LB. PAIL)	\$465.99

**BEST  
SELLER**

Multi-purpose, high-quality lithium grease (NLGI #2) offers extreme anti-wear protection under heavy loads, shock conditions, and normal loads. Passes a full 100 lb. Timken test. Extreme stability and consistency. Does not soften like some grease, allowing leakage away from the area where the grease is needed. Best choice for high heat applications.



<b>MOLY 5% PARAGON 3000 GREASE</b>		
108598	(SINGLE CARTRIDGE)	\$25.99
108599	(PACK - 10 CARTRIDGES)	\$145.99
108598-40	(CASE - 40 CARTRIDGES)	\$539.99
108505-4055	(45 LB. PAIL)	\$521.99

MOLY PARAGON 3000 is an extreme pressure, multi-purpose, calcium-lithium complex base grease with a minimum of 5% molybdenum disulfide. Specially formulated to use in industries with applications that experience extreme conditions such as high shock loading, high heat, moisture, or areas where stability is needed. It is excellent for use on bearings, pins, bushings, cam and slide mechanisms, and chassis points.



<b>TRC 880 CROWN &amp; CHASSIS GREASE (100 TIMKEN LOAD)</b>		
108455-8456	(SINGLE CARTRIDGE)	\$17.99
108455-8457	(PACK - 10 CARTRIDGES)	\$105.99
108455-8456-40	(CASE - 40 CARTRIDGES)	\$391.99
108455-4055	(45 LB. PAIL)	\$379.99

The "red grease with golden flakes" is a favorite nationwide - from industrial to agriculture, to trucking. 880 C&C meets and exceeds the demands of a multi-purpose lubricant. With a Timken load rating of 100 pounds minimum, 880 C&C meets special lubrication needs, providing the ultimate in extreme pressure protection. It's excellent for use on ball joints and fifth wheels, which are constantly placed under heavy loads. Impervious to water, 880 C&C stays put.

**PARAGON 3000 LITHIUM GREASE LUBE-SHUTTLE®**

108500-1097	(SINGLE CARTRIDGE)	\$21.99
108500-1096	(PACK - 10 CARTRIDGES)	\$160.99
108500-1097-40	(CASE - 40 CARTRIDGES)	\$596.99



Paragon 3000 now available in a threaded cartridge for our SPIN-ON GREASE GUNS (p.13)

**AIRTEC G200 EP GREASE  
3 oz. GREASE CARTRIDGES**

G200EP-3	(3 PACK)	\$13.99
----------	----------	---------

Calcium complex, extreme weather grease. 3 Pack of 3 oz. grease "mini" cartridges. Perfect fit for the LockNlube Mini Grease Gun (p.15).



# QUICK CONNECT GREASING ACCESSORIES

Reach any fitting on any machine with our wide selection of quick-connect greasing adapters. Whether it's a 90°, low clearance, or needle-tight access, LockNLube has you covered!

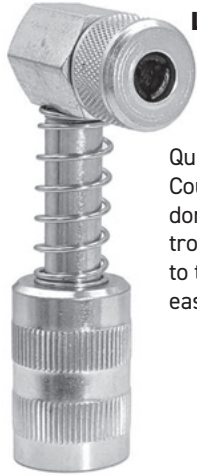

## LOCKNLUBE 90° ADAPTER LNL120 \$16.99

A 90° adapter for hard-to-reach grease fittings with three hardened steel jaws and a rubber seal.

Quickly connect to your LockNLube® Grease Coupler, or standard grease coupler, so you don't have to change your grease gun to reach troublesome fittings. Just connect your coupler to the Zerk fitting under the collar of this tool, and easily remove when done.

**BEST SELLER**



Learn more about our 90° Adapters here →



## LOCKNLUBE PUSH-ON 90° ADAPTER LNL121 \$10.99

A low-profile 90° adaptor for hard-to-reach grease fittings in areas with very little clearance over the Zerk. Fits standard and metric Zerk fittings. Easily connects to your LockNLube® Grease Coupler.

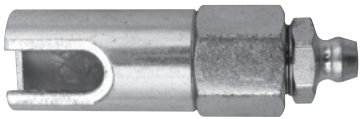

## LOCKNLUBE SIMPLE 90° ADAPTER LNL129 \$10.99

High-quality grease fitting and coupler make the Simple 90° adapter perfect for your LockNLube® Grease Coupler. Use in confined spaces where grease fittings are hard to reach.



## GREASE WHIP HOSE

GR88003	5" (125MM)	\$8.99
OS01015	12" (300MM)	\$10.99
OS01016	20" (500 MM)	\$12.99
OS01032	28" (750MM)	\$14.99

Upgrade your grease gun with a high-quality whip hose, available in 4 lengths. Both ends are male 1/8" NPT.

- Max Working Pressure: 5,800 psi (400 bar)
- Min Burst Pressure: 14,500 psi (1,000 bar)
- Min Bend Radius: 1.37 in. (35 mm)
- Working Temperature: -40 to 140° F (-40° to 60° C)

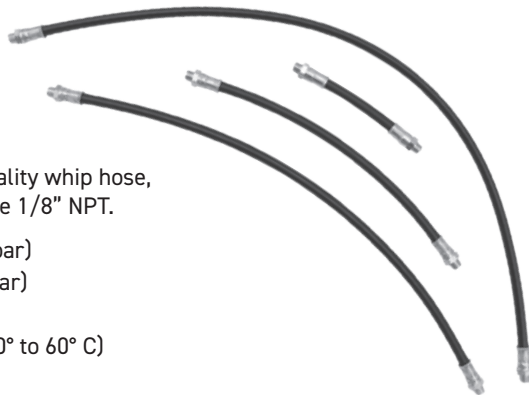

## SHORT NEEDLE TIP ADAPTER 05-042 \$4.99

For grease fittings in confined areas or for chainsaws, bicycles, and other grease points without Zerk fittings.



For manual grease guns.

## RECESSED FITTING EXTENSION LNL128 \$14.99

A rigid, narrow 3.5" extension for your grease coupler. Easily reaches Zerk fittings in recessed or confined areas. Tip has a concave cup shape to give some flexibility when positioning on the top of the Zerk fitting.



For manual grease guns.

## GREASE INJECTOR NEEDLE LNL123 \$3.99

Easily grease sealed bearings. Simply insert needle under or through rubber cover to apply grease to bearings. Made of 18 gauge steel with protective plastic cover.



For manual grease guns.

## NARROW NEEDLE DISPENSERS

### CHOOSE YOUR SIZE!

LNL122 REG \$10.99

OVERALL LENGTH: 3.125 IN/80 MM

LNL222 XL \$14.99

OVERALL LENGTH: 7.5 IN/190.5 MM

- Extra reach for hard-to-reach grease fittings
- Works best with the LockNLube® Grease Coupler
- Delivers a fine line of grease for shafts and other applications

For manual grease guns.

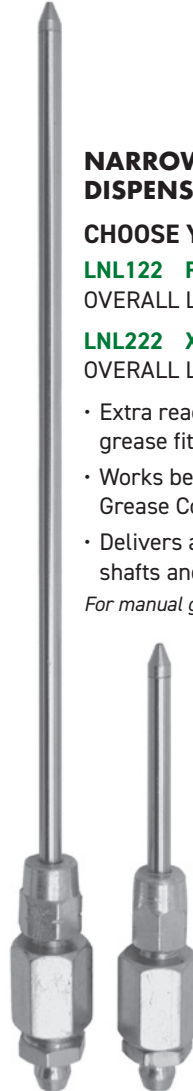

## STRAIGHT ZERK FEMALE 1/8" NPT

1618-B \$1.99

Perfect for building your own grease fitting relocation hoses. These fittings have Trivalent zinc plating and are RoHS compliant.



## QUICK-CONNECT HOSE ADAPTER LNL126 \$9.99

Access hard-to-reach grease fittings with this 12" extension hose. Includes a heavy-duty 4-jaw grease coupler. Works best with the LockNLube® Grease Coupler.

For manual grease guns.

## SEAL-OFF GREASE ADAPTER LNL127 \$9.99

Used for lubricating grease plugs, chainsaw tips, or any other grease ports that do not have Zerk fittings. The grease fitting in the back of the adapter easily locks into your LockNLube® Grease Coupler so you can attach this quickly when needed.

For manual grease guns.





LockNlube  
Cotton Hat  
Page 41

LockNlube®  
Grease Coupler  
Page 5

8-pc. Quick Connect  
Greasing Accessory Kit  
Page 23

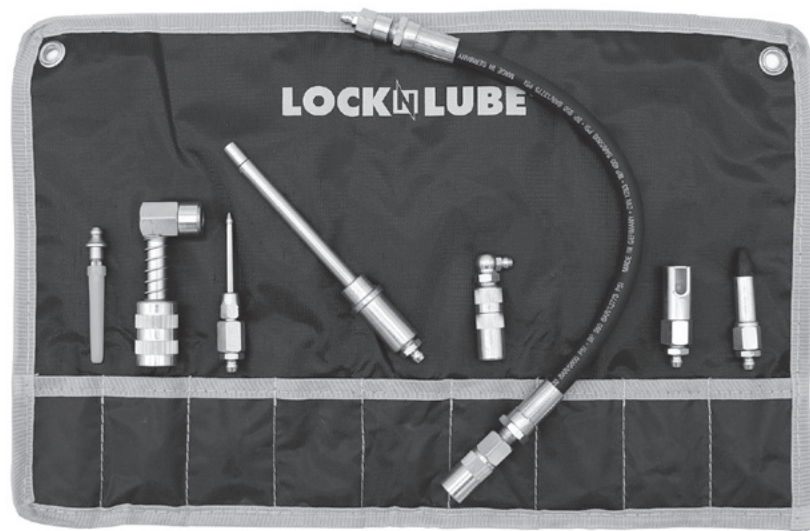

### 8-PC QUICK-CONNECT GREASING ACCESSORY KIT

LNL210

\$74.99

You save over 15% vs. buying all 8 separately!

Eight quick-connect adapters allow access to hard-to-reach grease fittings.

#### Features:

- The rip-stop case can be rolled and secured with an attached velcro strap to keep tools clean and portable
- Grommets allow hanging for easy access to the tools
- All tools include a Zerk fitting in the back for easy connection and release from LockNlube® or a traditional, grease coupler

#### Includes:

- LNL120 - 90° Grease Coupler Adapter
- LNL121 - Push-On 90° Grease Coupler
- LNL122 - Narrow Needle Nose Dispenser
- LNL123 - Grease Injector Needle
- LNL126 - Quick-Connect Grease Hose Adapter
- LNL127 - Seal-Off Grease Adapter
- LNL128 - Recessed Fitting Adapter
- LNL129 - Simple 90 Degree Adapter

BEST  
SELLER

### LOCKNLUBE 48" UNIVERSAL GREASE HOSE

LNL271

\$39.99

Twin spring guards prevent kinks and cracks and ensures safety with cordless battery grease guns. A flexible, heavy-duty hose with 28,000 PSI burst pressure. 7/16"-28 base end threads compatible with Lincoln and DeWalt® cordless battery grease guns. Included adapters ensure compatibility with all cordless grease guns on the market: 7/16"-20 for Milwaukee® battery, 1/8" NPT for manual grease guns or other brands' cordless models. Working hose end is a standard 1/8" NPT male connection compatible with LockNlube® or other grease couplers.



## COMPLETE GREASE FITTING REPLACEMENT KIT

**LNL143 \$59.99**

Includes most common SAE and metric grease fittings, large and small multi-tools, and 20 plastic caps to keep grease fittings clean and help them last longer. Bright plastic case keeps parts clean and easy to find even on the job site or the back of a dark truck.

### Includes:

- Straight grease fittings in four sizes (10 each): 1/8" NPT, 1/4"-28 SAE-LT, 6x1 metric, 8x1 metric
- 90 degree SAE fittings (5 each): 1/8" NPT, 1/4"-28 SAE-LT
- Multi-tools (small and large) to replace fittings, remove broken fittings, and retap stripped holes
- 20 fittings caps, 10 each of yellow and red



## GREASE FITTING THREAD TESTER

**LNL132 \$39.99**

This aluminum thread tester helps you easily identify thread patterns for all common standard and metric grease fittings.

## GREASE FITTING MULTI-TOOL

Easily install and extract grease fittings, or re-tap stripped holes. Two sizes available:

### LARGE: 1/8" NPT THREAD - LNL125 \$10.99

- Fits 1/8" NPT, BSPT, M10x1 and other fittings with hex size 3/8" (9mm) and 7/16" (11mm)

### SMALL: 1/4" 28 THREAD - LNL124 \$9.99

- Fits 1/4"-28, M6x1, M8x1 and other fittings with hex size 5/16" (7mm) and 3/8" (9mm)



**BEST SELLER**

## GREASE FITTING SETS

### 80 PCS - SAE

**LNL141 \$36.99**

- 1/8" - 27 PTF Straight (25)
- 1/4" - 28 SAE LT Straight (15)
- 1/4" - 28 SAE LT 45° Angle (10)
- 1/8" - 27 PTF 45° Angle (10)
- 1/8" - 27 PTF 90° Angle (10)
- 1/4" - 28 SAE LT 90° Angle (10)

### 80 PCS - METRIC

**LNL142 \$36.99**

- M6 x 1 Straight (20)
- M6 x 1 90° Angle (10)
- M10 x 1 Straight (15)
- M8 x 1 Straight (15)
- M8 x 1 90° Angle (10)
- M10 x 1 90° Angle (10)

*Fittings from LNL141 & LNL142 are also sold in multi-packs (p.26) or individually on our website.*

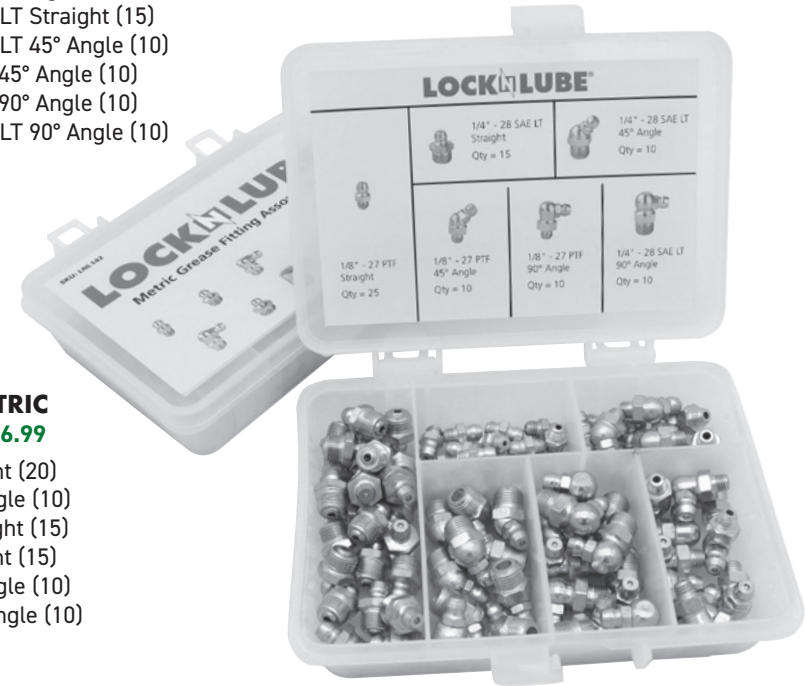

### STAINLESS STEEL - 40 PCS - SAE

**LNL140 \$79.99**

- 1/4" - 28 SAE LT Straight (10)
- 1/8" - 27 PTF Straight (10)
- 1/8" - 27 PTF 45° Angle (5)
- 1/8" - 27 PTF 90° Angle (5)
- 1/4" - 28 SAE LT 90° Angle (5)
- 1/4" - 28 SAE LT 45° Angle (5)

**STAINLESS STEEL**  
**SS**



# DID YOU KNOW?



THE MODERN GREASE FITTING IS CALLED A "ZERK" BECAUSE IT WAS INVENTED BY OSCAR U. ZERK.



Alemite had already been marketing, since 1919, ball check valves to accept grease supplied under pressure from a grease gun. However, Oscar Zerk's fitting was an improved style, less vulnerable to dirt and more forgiving of an angled approach.

In 1929, Oscar Zerk created a refined version of his lubrication nipple and assigned the patent to Alemite. Today, many companies make these grease fittings.

Source: Wikipedia

## GREASE FITTING MULTI-PACKS

LockNLube offers a full selection of the most popular grease fitting sizes and threads in convenient multi-packs.

Suitable for agricultural, lawn and garden, automotive, and industrial applications.

LNL81507	1/8" NPT, STRAIGHT 10-PACK	\$5.99
LNL81511	1/8" NPT, 30° 10-PACK	\$5.99
LNL81513	1/8" NPT, 90° 10-PACK	\$5.99
LNL81537	1/4"-28 TAPER, 45° 10-PACK	\$5.99
LNL81541	1/4"-28 TAPER, STRAIGHT 10-PACK	\$5.99
LNL81512	1/4"-28 TAPER, 90° 10-PACK	\$5.99
LNL81527	1/4" SAE, STRAIGHT 5-PACK	\$5.99
LNL81529	1/4" SAE, 67.5° 5-PACK	\$5.99
LNL81588	1/8" NPT, 45° 10-PACK	\$5.99
LNL81543	1/4" STRAIGHT DRIVE 10-PACK	\$5.99
LNL81503	8MM, STRAIGHT 10-PACK	\$5.99
LNL81505	8MM, 90° 10-PACK	\$5.99
LNL81506	6MM, STRAIGHT 10-PACK	\$5.99
LNL81508	6MM, 90° 10-PACK	\$5.99
LNL81509	10MM, STRAIGHT 10-PACK	\$5.99
LNL81580	1/4"-19 BSPT STRAIGHT	\$5.99
LNL85575	1/8"-28 BSPT 90 DEGREE	\$5.99
LNL81560	1/8"-28 BSPT STRAIGHT	\$5.99
LNL81556	5/16"-24 UNF-2A	\$5.99



**NEW!**

## GREASE FITTING RELOCATION KITS

### RELOCATION MANIFOLD KITS

LNL81203-1/8	THREE POINT 1/8 MANIFOLD KIT	\$149.99
LNL81204-1/8	FOUR POINT 1/8 MANIFOLD KIT	\$189.99
LNL81206-1/8	SIX POINT 1/8 MANIFOLD KIT	\$249.99
LNL81203-1/4	THREE POINT 1/4-28 MANIFOLD KIT	\$149.99
LNL81204-1/4	FOUR POINT 1/4-28 MANIFOLD KIT	\$189.99
LNL81206-1/4	SIX POINT 1/4-28 MANIFOLD KIT	\$249.99

**NEW!**

You know how important it is to keep your costly equipment properly greased and maintained. Now we offer the best way to make that task more efficient than ever before. Introducing our innovative Grease Fitting Relocation Manifold Kits - the ultimate solution to simplify and streamline your machine lubrication process!

Our kits make it easy to run grease hoses from multiple fittings on your machine to a central grease fitting manifold. By bringing all of your grease points to a central location, you make the task of lubricating the machine faster and easier with less mess and less downtime.

Choose from 3, 4, or 6 connection manifolds. Each kit comes with an extra long roll of pre-filled grease hose that you cut to length. All the hardware is included to bring multiple grease points to one, central, easy-to-service greasing point. Hose clips are sold separately.



### CUSTOM GREASE FITTING RELOCATION KITS

**GFRK \$9.99 - \$20.99**

**BUILD YOUR OWN BUNDLE!** Choose a hose length, a Zerk, and an elbow.

The LockNLube Grease Fitting Relocation Kit replaces hard-to-reach grease fittings with a high-quality 5", 12", 20", or 30" flexible hose and your choice of adapter. The hose is capped with a Zerk so you can locate the access point wherever you like. See page 20 for hose options.

Visit our website or call 603-795-2298 for exact pricing and options.



### LOCKNLUBE MAGNETIC GREASE FITTING RELOCATION BLOCK

**LNL220 \$34.99**

A simple, fast way to relocate hard-to-reach fittings! Locking hose swivels (1/8" NPT) accept one or two hoses into a single manifold. No drilling or custom hose crimping is required. Simply replace the fitting with an adapter (if needed) and 1/8" NPT grease hose (see p.20). Powerful rare-earth magnet resists vibrations and jolts so it will stay in place.

## MAGNETIC TOOL HOLDER

LNL81412 \$39.99

Strong magnetic tool holder keeps all your tools organized and within reach

- Eight powerful neodymium rare earth magnets with a chemical resistant urethane rubber covering
- Flexible construction easily adapts to any curved metallic surface
- Non-marring rubber coating will not damage tools or surfaces
- Eight variable sized slots: 3/16"-7/8" (7 mm-22 mm) to hold picks, adapters, screwdrivers, sockets, pliers, wrenches, and more!

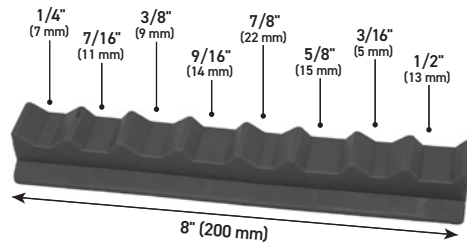

## PRY BABIES POCKET PRY BAR SET

LNL81411 \$19.99

Pocket sized pry bars with multiple uses around the shop, farm, or garage.

Crafted from durable 3/16" (4.75 MM) diameter hardened steel, each 5" (125 MM) bar has a corrosion-resistant black oxide finish to prevent rust and a durable plastic handle with stainless steel pocket clip.

Perfect for cleaning gunk from around zerk fittings, removing seals, lids, electrical connectors, clips, o-rings, caps, interior trim pieces, and more!



## GREASE GUN BARREL TOOLBELT

LNL130 \$19.99

Tired of misplacing your adapters when greasing? Would you like a handy little screwdriver to clear dirt and gunk away from your Zerks before you lock on your grease coupler? Check out the LockNLube Grease Gun Barrel Toolbelt!

Securely holds the **included** Screwdriver, Simple 90° Adapter, and Regular Narrow Needle Adapter. As well as a slot to clip in your LockNLube® Grease Gun Coupler! Equip your grease gun with all the tools you need on the job, order yours today—makes a great gift!

### PACKAGE INCLUDES:

- Rubber Grease Gun Barrel Toolbelt
- Screwdriver (flat head)
- Simple 90° Adapter
- Narrow Needle Adapter
- Fits standard 14 oz grease gun barrels



## LOCKNLUBE UNIVERSAL BEARING PACKER

LNL145 \$13.99

Universal Bearing Packer with threaded center post for use with grease guns. The design incorporates a standard grease fitting at one end which easily connects to any grease gun coupler. Heavy-duty, all-metal construction. Cone diameter is 4 1/2".

Suited for bearings with a min. inner diameter of 1/2" (12 mm), to a max. outer diameter of 5" (125 mm) and height from 1/4" (6 mm) to 2" (50 mm)



## HEAVY-DUTY GREASE GUN HOLDER

LNL133 \$19.99

Industrial strength holder can be mounted to walls, machinery, or heavy equipment. It is designed to retain your grease gun securely even in high vibration environments. Works with all standard 14 oz. grease guns.

Mounting hardware not included.



## MAGNETIC GREASE GUN HOLDER AND DRIP CUP

LNL81135 \$29.99

- Works with standard barrel grease guns that hold a 14 oz. grease tube
- Powerful rare earth magnets keep the holder and cup securely attached to tool chests, cabinets, or other flat metal surfaces
- Position the drip cup below your grease gun barrel to make sure your floor surfaces stay clean and hazard free.



## THE ORIGINAL GREASE BUSTER®

GB17 \$54.99

Open up clogged grease fittings with the Grease Buster®. Simply fill with a solvent and tap the piston with a hammer. The updated design includes a textured grip and two O-rings on the piston. Manufactured by LockNLube in the USA.

- Cleans and flushes out old dried grease from fittings, pins, shafts, bushings, and joints
- Uses penetrating fluid and hydraulic pressure
- Reduces downtime. Much cheaper than new bearings!
- Hose extension and pneumatic piston available separately

BEST SELLER

MADE IN USA



## PNEUMATIC PISTON

GB18 \$22.99

Our pneumatic piston replaces the included Grease Buster® piston to take advantage of the added force and vibration of an air hammer. Double O-ring for extreme performance and durability.



## HOSE EXTENSION

GB19 \$14.99

The 5" Hose Extension replaces the installed Grease Buster® coupler to make it easier to reach clogged fittings in tight spaces. Includes a heavy-duty 4-jaw coupler to attach securely to your Zerk.



## KROIL PENETRATING OIL

KL081 \$19.99

When it comes to freeing corroded items in tough spaces nothing rivals powerful, industry-proven Kroil penetrating oil. Used and trusted by pros and experienced DIYers alike since 1939, Kroil quickly loosens rusted nuts and bolts, frees frozen shafts, and pulleys. No space is too tight to reach thanks to Kroil's ability to penetrate the smallest opening, thread or crevice. Corrosion meets its match, as Kroil removes and prevents rust, cleans and lubricates, and displaces moisture.

8 oz. can with cap



# HOSEBOX

## INDUSTRIAL FITTINGS MADE EASY

LockNLube is proud to partner with HOSEBOX, the industry leader in hydraulic fittings supply and education. HOSEBOX's quality fitting kits minimize downtime and get your equipment back on the job fast, saving you money!

With HOSEBOX, every hydraulic fitting and kit is meticulously engineered to meet and surpass SAE standards. HoseBox products embody a relentless commitment to quality, delivering an experience that sets them apart in the hydraulic solutions industry.

### CAP AND PLUG PACK

AVAILABLE IN 7 THREAD TYPES

Cap and Plug Packs come in the same extreme-duty containers as Fittings Packs and are filled with a variety of carefully selected caps and plugs to cover a range of repair solutions.

### FITTINGS PACK

AVAILABLE IN 7 THREAD TYPES

Designed to fit inside the Fittings Tower or used individually, Fittings Packs feature a rubber seal and two extra latches for added water-resistant sealing.

### O-RING PACK

AVAILABLE IN 4 THREAD TYPES

O-Ring Packs come loaded with carefully selected, high-quality hydraulic seals covering an extensive range of repair solutions and sizes.

### FITTINGS TOWER

INCLUDES 4 FILLED FITTINGS PACKS

Available in 6 different thread types, the Fittings Towers come stocked with 4 filled Fittings Packs, each housed in an extreme-duty, water-resistant compartment case.

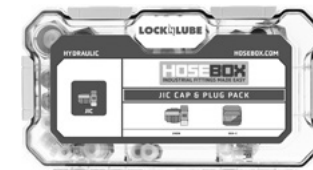

See our full line of Hosebox fitting kits on our website



### AVAILABLE IN THESE COMMON HYDRAULIC THREAD TYPES

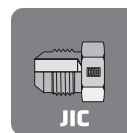

JIC

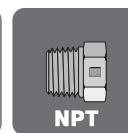

NPT



FACE SEAL

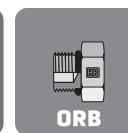

ORB

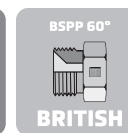

BRITISH

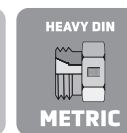

HEAVY DIN

METRIC

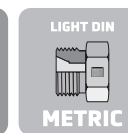

LIGHT DIN

METRIC

# TIRE INFLATOR/DEFLATOR KITS

Check out our best-selling, heavy-duty, aluminum diecast tire inflation/deflation kits!

Both kits include: 24" (600 mm) flexible SS hose with built-in swivel, LockNFlate® Air Chuck, and built-in pressure deflator valve. The heavy-duty construction is built to last and stand up to everyday use in even the busiest tire shops, service bays, and garages.

**BEST SELLER**

## TIRE INFLATOR/DEFLATOR WITH DIGITAL GAUGE

**LNL65301 \$139.99**

Large, easy-to-read, backlit digital display for pressure reading, readout, and programming

- Shock-absorbing rubber shroud protects digital components
- Max Pressure: Up to 300 PSI [21 Bar]
- 4 pressure measurement units (psi, bar, kPa, kg/cm2)
- Takes two AAA batteries (included)

## TIRE INFLATOR/DEFLATOR WITH ANALOG GAUGE

**LNL65303 \$109.99**

Our full diaphragm design guarantees precise readings 0-60 PSI [0-4.14 Bar].

- A shock absorbing rubber shroud and a robust full diaphragm design built to withstand the toughest conditions.
- Featuring a large, clear dial and easy-to-read markings, checking your tire pressure has never been easier or more convenient.

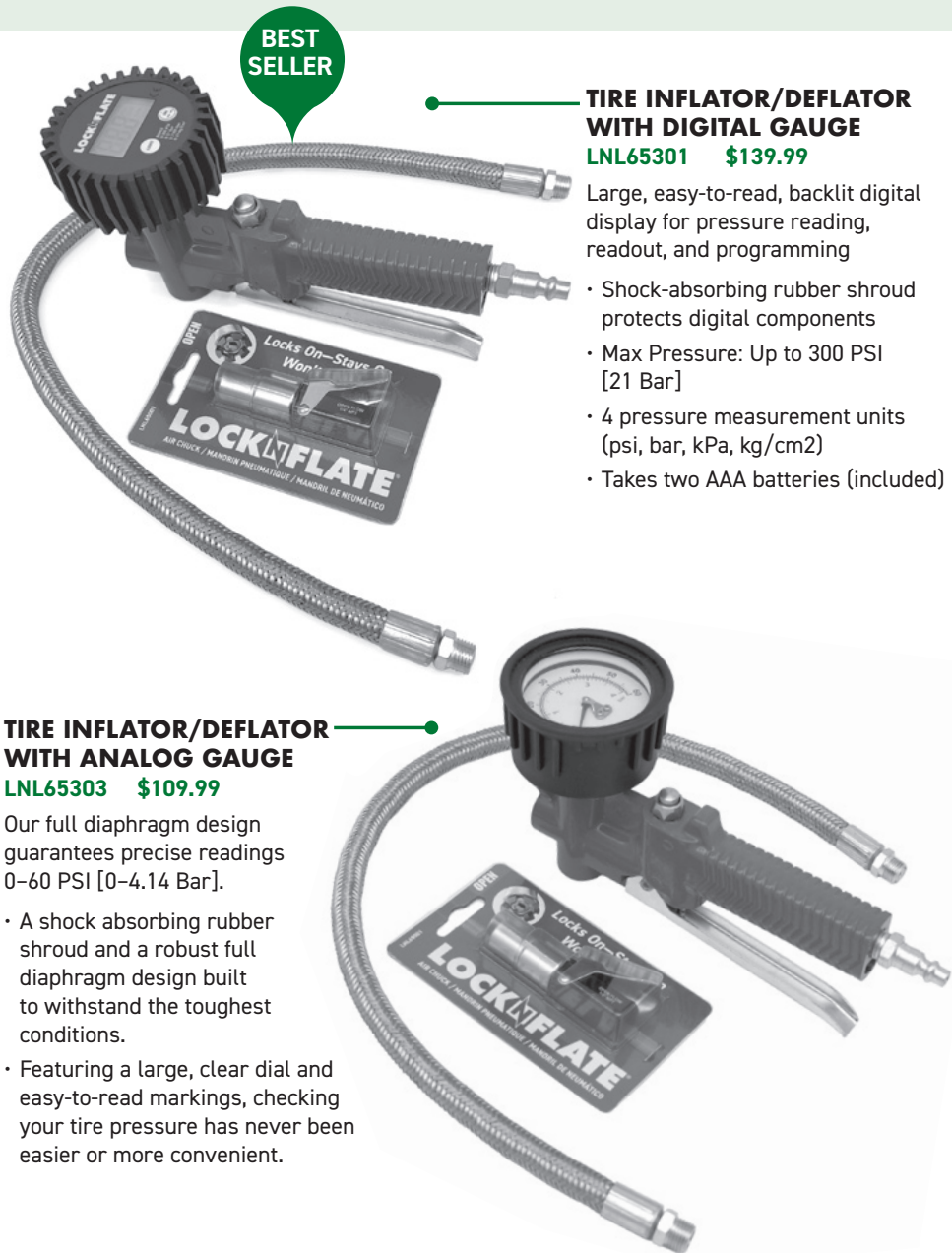

**BEST SELLER**

## LOCKING DUAL WHEEL ADAPTER - 15.5" LNL65107 \$99.99

Two jaw locking design with a patented remote actuator. Extended reach to securely inflate duals. Easily disconnect with the actuator, no need to reach in to disconnect.

Overall Length: 15.5" (40 cm)  
Max pressure: 150 PSI (10.3 BAR)

## DUAL WHEEL ADAPTER - 13.5" LNL65106 \$29.99

Dual head air chuck

Overall Length: 13.5" (33 cm)  
Max pressure: 150 PSI (10.3 BAR)

## ANGLED DUAL WHEEL ADAPTER - 9.5" LNL65103 \$14.99

Dual head air chuck

Overall Length: 9.5" (24 cm)  
Max pressure: 150 PSI (10.3 BAR)

The actuator slides forward and back to unlock the jaws from the tire valve.

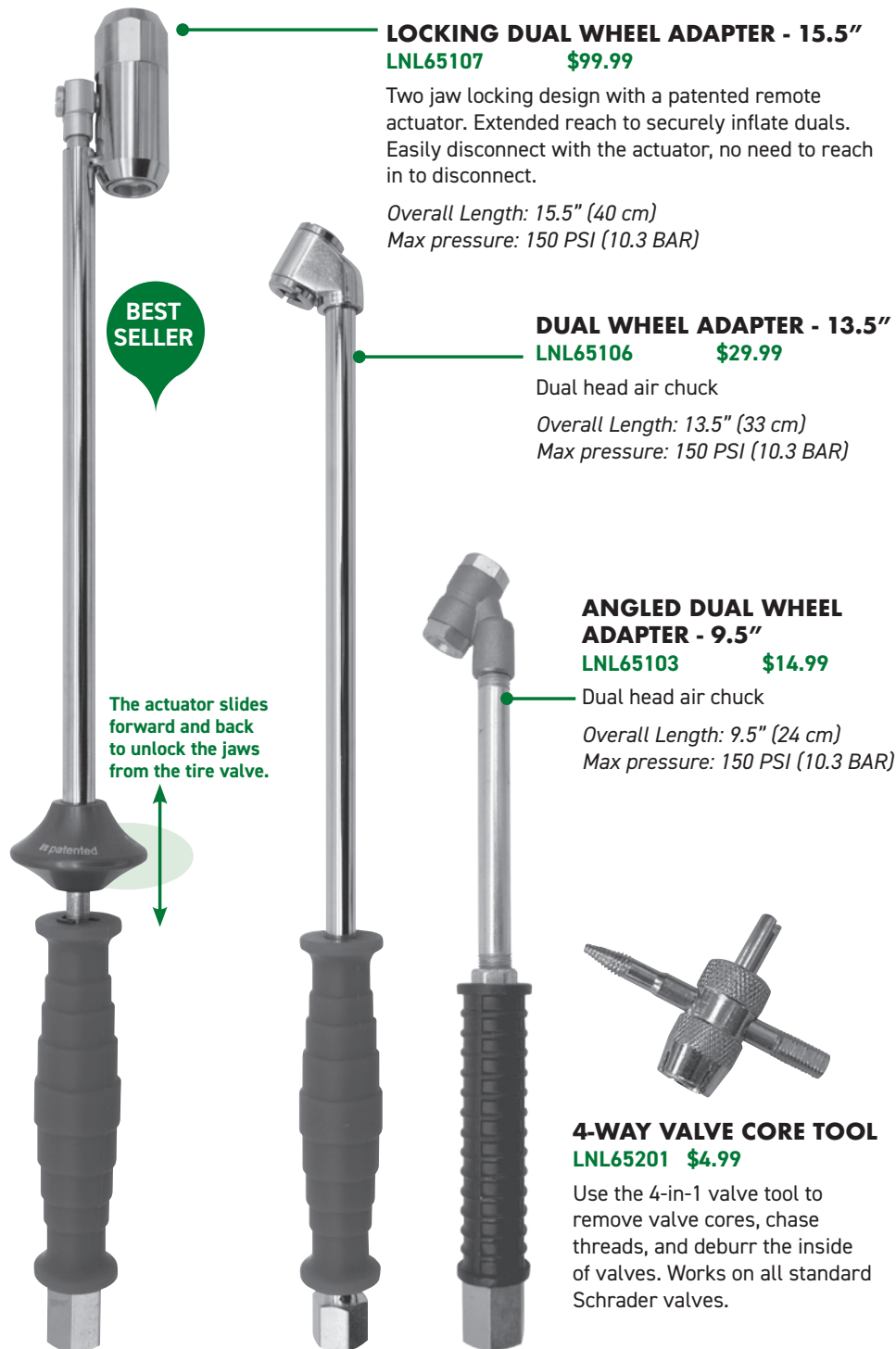

## 4-WAY VALVE CORE TOOL LNL65201 \$4.99

Use the 4-in-1 valve tool to remove valve cores, chase threads, and deburr the inside of valves. Works on all standard Schrader valves.

## PRE-SET DIGITAL TIRE INFLATOR GAUGE

LNL65302

\$399.99

The ultimate tool for the professional technician, as well as anyone who demands the highest quality tools for their shop. Set your desired pressure and this state-of-the-art inflator/deflator does the rest!

Pick your desired tire pressure or use the two presets for your most common pressures. Engage the **included LockNFlate® Air Chuck** and let the inflator work without holding anything in place. The inflator gives a loud beep when it's done so you know when to set down your cup of coffee and return to the tire.

- Rechargeable lithium-ion battery provides up to 15 hours of continuous use
- Audible beep indicator when the set pressure is reached. No need to stand by and watch the screen
- Tough polycarbonate body is shock and impact-proof. Can handle hard work in rough environments
- OPS: Built in over-pressure setting for exact seating of tire on the rim. Great to use when setting new tires
- 4 pressure measurement units (psi, bar, kPa, kg/cm<sup>2</sup>)

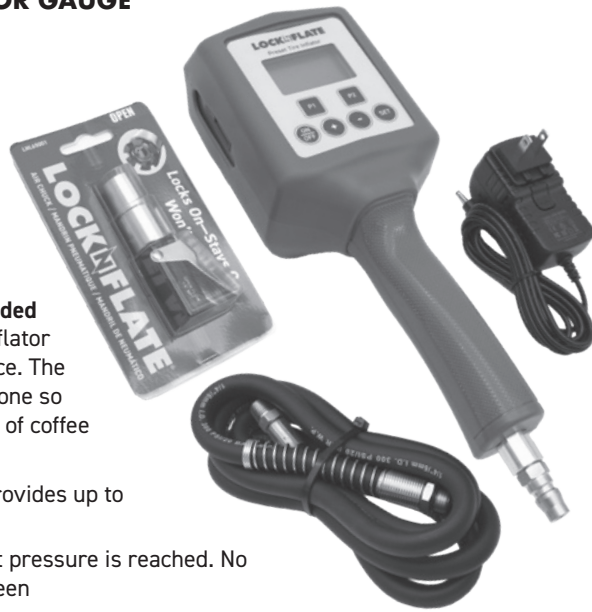

## MILWAUKEE® M18™ CORDLESS TIRE INFLATOR KIT

2848-20-KIT

\$219.99

We've combined the best 18V cordless inflator on the market with our LockNFlate Air Chuck and precision-machined adapter to create a powerful cordless combo that locks on, stays on, and won't leak... hands-free!

*Batteries are sold separately.*

- Auto pressure check feature activates to ensure PSI target is achieved
- Automatic shut-off at selected PSI prevents overinflation
- 4 PSI memory presets
- On-board hose & nozzle storage
- Anti-vibration rubber feet to minimize walk
- Inflation needle, inflator nozzle, and presta chuck included
- Sold only as a kit with all 3 pieces

The Milwaukee logo, featuring the word 'Milwaukee' in a stylized, italicized font with a lightning bolt graphic underneath.

## LOCKNFLATE FIVE PIECE BLOW GUN KIT

LNL65202

\$29.99

Lightweight Air Blow Gun Kit is great for clearing debris, removing dirt and dust, and drying wet surfaces.

- Impact and weather-resistant nylon body and trigger
- 4 1/2" (114 mm) long nozzle to access hard-to-reach areas
- Brass threaded air inlet ensures that threads do not shear with repeated use
- The package doubles as a convenient storage tray!
- Variable speed trigger for full control of the airflow
- Vent in the gun tip prevents pressure build-up beyond 30 PSI ensuring safety & OSHA compliance at all times

Four interchangeable tips for different applications



## THE PRO FILL™ AIR CHUCK FROM MOTION PRO™

08-0602 \$42.99

We set out to find the best-built, most adjustable, multi-angle adapter for hard-to-reach tire valves, and this is it! The Pro™ Fill Air Chuck from Motion Pro has a unique pivoting angled head design that provides added hand clearance and allows access to difficult-to-reach tire valves. Its billet aluminum construction is lightweight and has a precise fit. Utilizing our custom tire inflator adapter, it's the perfect complement to the LockNFlate® Air Chuck. (Both sold separately)

- Stainless steel banjo pivot bolt provides durable performance
- Pivoting angled head design allows access to difficult-to-reach tire valves
- Unique design provides added clearance between filler and hot brake rotors
- Billet aluminum construction for lightweight and precise fit and function
- 1/4" NPT female inlet allows use of common air hose couplings and fittings
- Blue anodized finish
- US Patent No. 9,649,898
- Lifetime limited warranty through Motion Pro



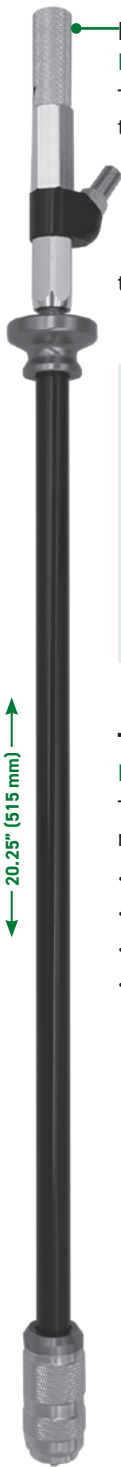

### LOCK ON VALVE CORE INFLATOR TOOL

LNL65204 \$79.99

This all-in-one tire valve tool does it all! Lock it securely to your tire's valve, and twist the knurled handle to remove the valve core. The valve core is stored inside the tool while you fill the tire!

No more lost or damaged valve cores, no more lost air. The extra length makes it easier than ever to fill high-volume truck tires quickly and easily.



### STAINLESS STEEL BRAIDED AIR HOSE

LNL65401 \$14.99

- Length: 3 feet (0.915 meters)
- Connections: 1/4 Inch Male NPT
- Construction: Braided Stainless Steel outer protective cover. Heavy-duty rubber core.
- Max. Working Pressure: 300 PSI



### TIRE PRESSURE GAUGE (DIAL)

LNL65205 \$14.99

The perfect accessory for your car, truck, motorcycle, bike, SUV, RV or ATV!

- Easy to read 2.5" dial
- Calibrated: 5-60 psi
- 45 degree angled chuck
- Sturdy design and protective rubber bumper resists damage from drops.



### TIRE PRESSURE GAUGE (STICK)

LNL65203 \$19.99

Stick-type tire pressure gauge perfect for trucks, SUVs, RVs, ATVs, bikes, or motorcycles, with a Schrader valve.

- Steel body with black zinc die-cast chuck and convenient hanging ring
- Length 12.25" (311 mm)
- Dual Chuck Design: 30° reverse chuck is designed for inner wheels or difficult-to-reach valves and straight chuck is used for outer wheels
- Four-sided, chrome plated, steel read-out scale shows tire PSI with easy-to-read graduations



### LOCKNFLATE TIRE INFLATOR ADAPTER 1/4" NPT (M) TO STANDARD SCHRADER VALVE (M)

LNL65196 \$9.99

Precision-machined tire inflator adapter that easily connects the LockNFlate® Air Chuck to any inflator or pump with a screw-on, or other, female Schrader valve connection such as the Milwaukee® M18™ Inflator, and others.



BEST SELLER

MADE IN USA

### MILTON® FITTING TO 1/4" NPT ADAPTER

LNL65197 \$9.99

Custom adapter to mate the LockNFlate® Air Chuck with the Milton® 500-Series tire inflators. Call us at 603-795-2298 for more information about compatibility.

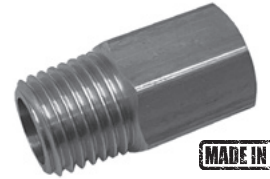

MADE IN USA

### AIR COUPLER QUICK CONNECT

LNL65101 \$5.99

1/4" NPT(F) to quick connect coupler. 1/4" Basic flow size with air flow capacity of 40 standard cubic feet per minute. Both the body and sleeve are made of brass.



### 360° SWIVEL AIR PLUG

LNL65231 \$4.99

- Milton® M-STYLE® compatible coupling for pneumatic grease guns, impact wrenches, and other air operated tools
- Built-in 360° swivel gives you maneuverability to prevent kinking or damage to hose
- 1/4" NPT (m) fits standard air hoses
- Rated to 150 PSI



### AIR PLUG QUICK CONNECT TO 1/4" NPT, 2 PACK

LNL65102 \$4.99

1/4" NPT (M) to Milton® M-STYLE® compatible coupling. Suitable for pneumatic tools such as air compressors, air hoses, blow guns, air nails, etc. Made of high-quality, rust-resistant plated steel. Two quick connects per pack.





**BEST  
SELLER**

**CLIP BENDER®**  
CB001 \$18.99

The Clip Bender® is a patented hand tool used for securing T-Post fence clips. It is made in the USA of 100% steel with a black oxide coating to prevent rust. The comfortable rubber handle is bright yellow for greater visibility. With its durability and unique design the Clip Bender® is without a doubt the best tool for the job!

**MADE IN USA**

# Clip Bender®

The ideal tool for securing T-Post fence clips



**WORKS ON:** Barbed Wire, Woven Wire, Hog Wire, Stock Panels, Horse Panels

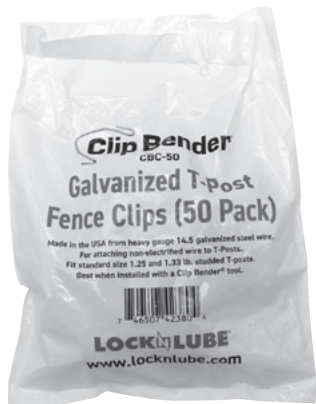

**GALVANIZED T-POST FENCE CLIPS**

<b>CBC-50</b>	<b>\$8.99</b>
<b>CBC-100</b>	<b>\$15.99</b>
<b>CBC-500</b>	<b>\$59.99</b>
<b>CBC-1000</b>	<b>\$89.99</b>

Made in the USA from heavy gauge 14.5 galvanized steel wire. For attaching non-electrified wire to T-Posts. Fit standard size 1.25 and 1.33 lb. studded T-posts. Best when installed with a Clip Bender® tool.

Available in 50, 100, 500, 1,000 packs



## JAKE'S WIRE TIGHTENERS

Fix your loose fence wire quickly and inexpensively without cutting wire.

**JAKE'S WIRE TIGHTENERS**

<b>11572A-20</b>	<b>1/4" BAG OF 20</b>	<b>\$39.99</b>
<b>11572A-400</b>	<b>1/4" CASE OF 400</b>	<b>\$529.99</b>
<b>11672A-15</b>	<b>5/16" BAG OF 15</b>	<b>\$49.99</b>
<b>11672A-225</b>	<b>5/16" CASE OF 225</b>	<b>\$529.99</b>

Jake's Wire Tighteners are a reusable, effective, and easy solution for tightening wire. Available for 1/4" diameter wire and 5/16" diameter wire.

- Simple Application: just insert and wind
- Less cost than a crimp sleeve
- Quick and easy to use
- Requires Jake's Wire Tightener Handle to install, sold separately

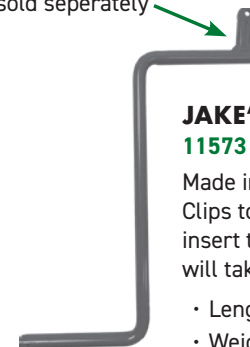

**MADE IN USA**

**JAKE'S WIRE TIGHTENER HANDLE**

**11573 \$15.99**

Made in the USA. This handle twists both regular and heavy-duty Jake's Clips to apply tension and take up slack in loose or mended wire. Simply insert the tab into the Jake's Clip and use both hands to rotate. The clip will take up slack and tighten the wire.

- Length: 11 inches. Each arm is 4.5 in long for a total height of 9 in.
- Weight: 1.2 lbs

**DOUBLE ACTION TRANSFER PUMP**

**LNL159 \$19.99**

Transfer fluids easily with no mess or spills!

- Rugged aluminum die-cast head
- Steel barrel in premium powder-coated finish with heavy duty rubber plunger
- Capacity: 350ml (12 oz.)
- 'V' type drop-resistant plunger handle
- Complete with 8' of vinyl hose (4' with each valve)

**Recommended Uses:** Fuel Oils, Mineral Oils, Synthetic & Biological Oils, Cooling Liquids and Spirits



Get those hard  
to clean areas  
turn by turn!



# Wand Wizard®



Easily adjusts from 0° - 90°

Multi-Position Rotating Axis

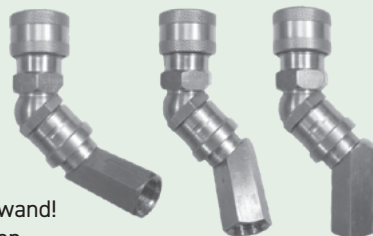

**QUICK COUPLING** WW15 \$19.99  
**1/4" FEMALE NPT** WW20 \$19.99

Quickly change the spray angle on your pressure washer wand!  
Straight across to straight down, and everything in between.

## PRESSURE WASHER QUICK COUPLING

**D10001 FNPT** \$8.99  
**D10002 MNPT** \$8.99

AVAILABLE IN TWO STYLES

D10001 GP Pressure Washer Quick Coupler  
Female Socket 1/4" FNPT Brass

D10002 GP Pressure Washer Quick Coupler Male  
Socket 1/4" MNPT Brass



Connect and disconnect your pressure washer hoses,  
guns, and nozzles with these high-quality couplers.  
Recommended for use with our Wand Wizard®!

## LOCKNLUBE POCKET T-SHIRT

LNL923-M MEDIUM \$17.99  
LNL923-L LARGE \$17.99  
LNL923-XL XL \$17.99  
LNL923-2XL 2XL \$17.99

Charcoal, 100% cotton, pocket t-shirt.  
Works on the job site and anywhere  
else you choose to wear it. Join the  
LockNLube Maintenance Division today!



## LOCKNLUBE LOW PRO TRUCKER

LNL901 BLACK \$17.99

Low crown, mesh-back trucker hat.  
The most popular hat style at the  
construction shows this year, now  
available from LockNLube!



## LOGO STICKERS

STK0004 \$1.99

FOUR stickers on a single 6" x 4" sheet.

- LockNLube Logo
- LockNFlate Logo
- LockNLube® Grease Coupler
- LockNFlate® Air Chuck

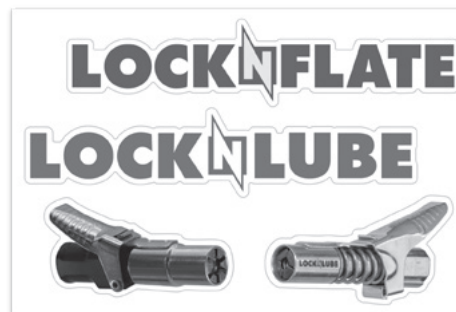

## LOCKNLUBE COTTON HAT

LNL902 BLACK \$17.99

Keep it simple with the lived-in look of this  
garment washed, unstructured ball cap.

## Mail-In Order Form

Please fill in the items requested with SKUs, quantities and totals and mail this form to:  
LockNLube • 24 Interchange Drive • West Lebanon, NH 03784

### Your Mailing Address:

Name: \_\_\_\_\_ Date: \_\_\_\_\_

Street Address: \_\_\_\_\_

City: \_\_\_\_\_ State: \_\_\_\_\_ Zip: \_\_\_\_\_

Phone: (required) \_\_\_\_\_ Email: \_\_\_\_\_



### ALL LOCKNLUBE BRAND PRODUCTS CARRY OUR 1-YEAR "BEST BUILT" GUARANTEE

We offer a 1-year satisfaction guarantee for all LockNLube brand products. If our products don't work better and last longer than the competition, you may return the product for a full refund or exchange.\*

SKU	Price	Quantity	Total

Free US shipping on orders over \$25.  
Other orders? Call or email for rates.

Prices **DO NOT** include sales tax. Call or email for exact rate.

Order Total:

SHIPPING
TAX
<b>TOTAL</b>

We Accept:



Card Number:

Expiration Date:   /   Security Code:

Billing Zip Code: (if different from mailing address) \_\_\_\_\_

Name on card: \_\_\_\_\_

Signature: \_\_\_\_\_

Please make check payments payable to: LockNLube

Please contact us with any questions or concerns at (603) 795-2298 or sales@locknlube.com

\*See website for details - www.locknlube.com

**LOCKN**LUBE

24 Interchange Drive  
West Lebanon, NH 03784

[www.locknlube.com](http://www.locknlube.com)  
603-795-2298

